

FD413-EA-000 EtherCAT Servo Drive

Kinco

FEATURES

- **Power Rating of 200 Watts**
- **220 VAC**
- **Open Network Based on Ethernet**
- **RS232 and EtherCAT**
- **Supports Modbus RS485 and RS232 Communication Protocol**
- **Rated Current 2A, Peak Current 7A**
- **Supports Pulse + Direction (PLS + DIR), Forward and Reverse Pulse (CW/CCW), and A + B Phase**
- **Programmable Inputs and Outputs**
 - **7 Inputs**
 - **4 Outputs**



DESCRIPTION

The FD413-EA-000 EtherCAT Servo Drive is an open network based on Ethernet to achieve real time control. It is capable of supporting very high speeds and synchronized control. The EtherCAT drive is best suited for establishing protocol in motion control and factory automation applications. With this technology the process of receiving Ethernet data, decoding the data, and then copying the process data to different devices, is not needed. The EtherCAT slave device can read the data marked with the devices address information when the frame passes this device. The EtherCAT Servo Driver includes 7 Digital Inputs and 5 Digital Outputs. Data reading and data writing could be done within several nanoseconds.

ADDITIONAL INFORMATION

Servo Driver	Servo Motor	Description	Power/Brake Cable	Encoder Cable	Rated Speed/ Rated Torque/ Rated Current
FD413-EA-000	SMS60S-0020-30JAK-3LKU	20 Bit Single-Turn Encoder	MOT-005-05-KL-Y	ENCDG-05-GU	3000rpm/ 90 oz-in/ 1.4A
	SMS60S-0020-30JBK-3LKU	20 Bit Single-Turn Encoder with Brake	MOT-005-05-KL-Y / BRA-05-KL	ENCDG-05-GU & ENCDG-(4)-GU-BT	3000rpm/ 90 oz-in/ 1.4A
	SMS60S-0020-30KAK-3LKU	16 Bit Multi-Turn Absolute Encoder	MOT-005-05-KL-Y	ENCDG-05-GU & ENCDG-(4)-GU-BT	3000rpm/ 90 oz-in/ 1.4A
	SMS60S-0020-30KBK-3LKU	16 Bit Multi-Turn Absolute Encoder with Brake	MOT-005-05-KL-Y / BRA-05-KL	ENCDG-05-GU & ENCDG-(4)-GU-BT	3000rpm/ 90 oz-in/ 1.4A

L011675

FD413-EA-000 EtherCAT
Servo Drive

Kinco

DIMENSIONS

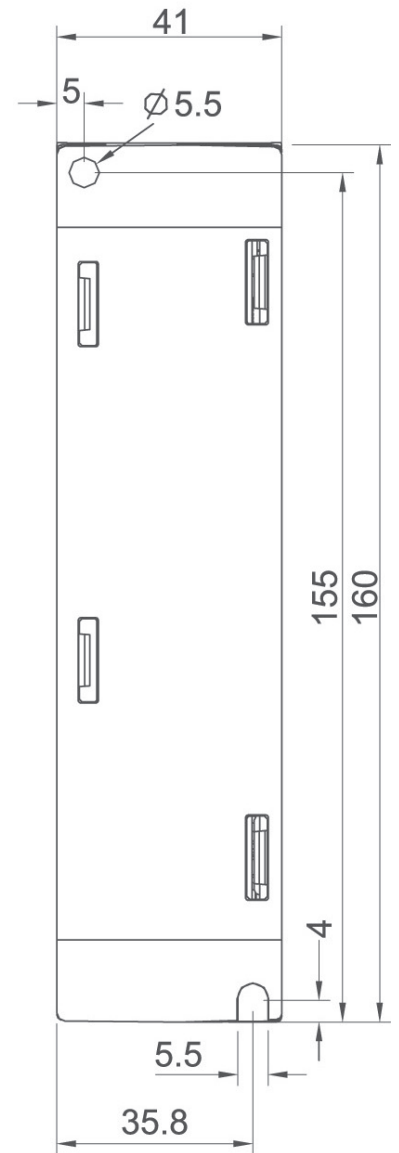
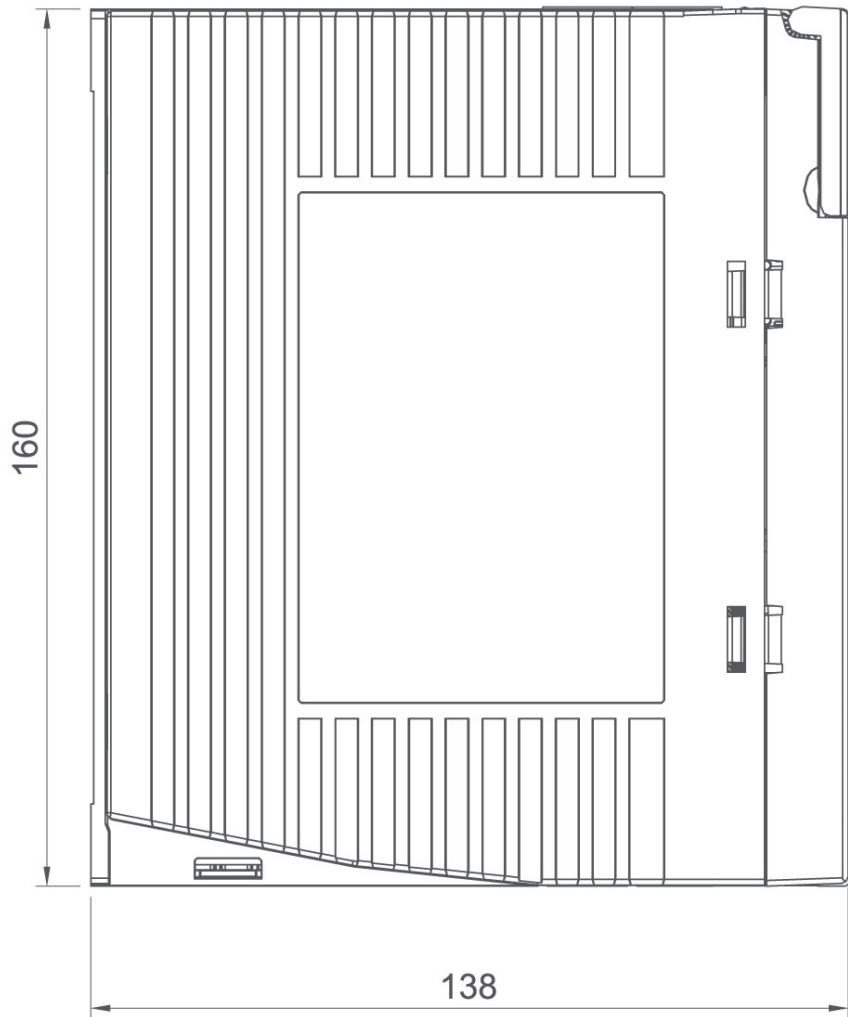

Note: All Dimensions in (mm)

FD413-EA-000 EtherCAT Servo Drive



TECHNICAL SPECIFICATIONS

Model Parameter		FD413-EA-000 Series
Power	Main Supply Voltage	200-240VAC \pm 10% 50/60Hz \pm 3Hz 0.5A
	Control Circuit Voltage	200-240VAC \pm 10% 50/60Hz \pm 3Hz (750W 5.5A) , (200W 1.5A)
Current	Rated Current (RMS)	2A
	Peak Current (PEAK)	7A
Feedback Signal		17 Bit Single-Turn Magnetolectric Encoder, 16 Bit Multi-Turn Absolute Encoder, 20 Bit Single-Turn Encoder
Brake Chopper		Inbuilt 100 Ohm/10W Brake Resistor. When the real power of Brake Resistor is over 10W, please add an external Braking Resistor (mainly in quick start and stop application)
Brake Chopper Threshold		DC380V \pm 5V
Over-Voltage Alarming Threshold		DC400V \pm 5V
Under-Voltage Alarming Threshold		DC200V \pm 5V
Cooling Method		Natural Air Cooling
Weight		0.8 Kg
Digital Input	Input Specification	7 Digital Inputs, with COM1 Terminal for PNP (High Level Valid 12.5-30V) or NPN (Low Level Valid 0-5V) connection.
	Input Function	Define Freely According to Requirement, Supporting Following Functions: Driver Enable, Driver Fault Reset, Driver Mode Control, Proportional Control, Positive Limit, Negative Limit, Homing Signal, Reverse Command, Internal Speed Section Control, Internal Positive Section Control, Quick Stop, Start Homing, Active Command, Switch Electronic Gear Ratio, Switch Gain, Position Table.
Digital Output	Output Specification	5 Digital Outputs, Maximum Voltage DC30V; OUT1 and OUT2 are Differential Outputs, Maximum Current 100mA; OUT3~OUT5 are Normal Outputs, Maximum Current 20mA; OUT2 is also a Brake Control Output Port, via Connecting a Relay to Control the Brake of Motor.
	Output Function	Define Freely According to Requirement, Supporting Following Functions: Driver Ready, Driver Fault, Positon Reached, Motor at Zero Speed, Motor Brake, Motor Speed Reached, Z Signal, Maximum Speed Obtained in Torque Mode, Motor Brake, Position Limiting, Reference Found, Multi-Position Reached.
	Encoder Signal Output Function	Output 5V A, B, Z Signal of Encoder from the Motor. Adjustable Encoder Resolution, Range: 0-65536. Maximum 2MHz Frequency Output
	RS232	The Max. Baudrate is 115.2KHz, use MODBUS RTU Protocol to Communicate with Controller.
	Protection Functions	Over-Voltage Protection, Under-Voltage Protection, Motor Over-Heat Protection (I ² T), Short-Circuit Protection, Drive Over-Heat Protection.
EtherCAT		Support CoE(CiA402 Protocol) and CSP/CSV/PP/PV/PT/HM Mode. Communication Speed 100M.
Operation Environment	Operating Temperature	0 ~ 40°C
	Storage Temperature	-10° C ~ 70°C
	Humidity (Non-Condensing)	Below 90%RH
	Protection Class	IP20
	Installation Environment	Installed in a Dust-Free, Dry and Lockable Environment (Such as in a Electrical Cabinet)
	Installation Mode	Vertical Installation
	Altitude	No Power Limitation Below 1000m
Atmospheric Pressure		86kpa-106kpa

FD413-EA-000 EtherCAT Servo Drive



INTERFACE

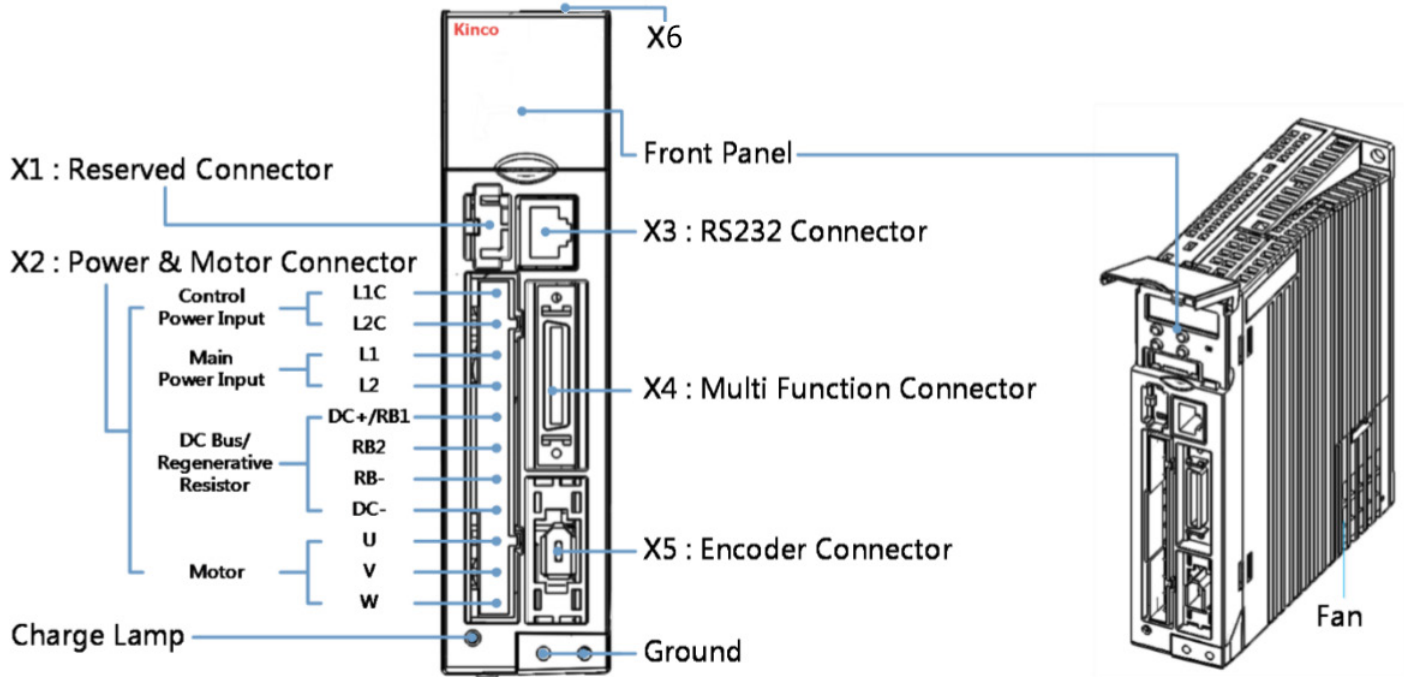

INTERFACE DESCRIPTION

Power Connector (X2)

PIN Number	Signal Marks	Signal
1	L1C	Control Power Input L/N
2	L2C	Single Phase 200-240VAC ±10% 50/60Hz, 0.5A Supply Earthing Systems: TN-S, TN-C, TN-C-S, TT (not corner earthed)
3	L1	Drive Power Input L/N
4	L2	Single Phase 200-240VAC ±10%, 50/60Hz 750W @7A, 400W @4.5A, 200W @3A, 100W @1.5A Supply Earthing Systems: TN-S, TN-C, TN-C-S, TT (not corner earthed)
5	DC+/RB1 (DC+)	DC bus+
5	DC+/RB1 (RB1)	External Braking Resistor Input
6	RB2	Internal Braking Resistor Input
7	RB-	External Braking Resistor Input
8	DC-	DC bus-
9	U	U Phase Power Output for Servo Motor
10	V	V Phase Power Output for Servo Motor
11	W	W Phase Power Output for Servo Motor

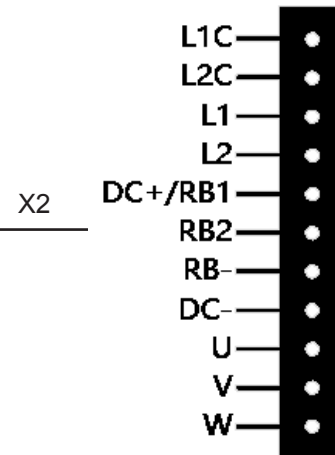

Information

Short Circuit DC+ / RB1 and RB2 if choosing controller internal braking resistor (power: 10W)

Note

It is forbidden to use the internal braking resistor if the average brake power is more than 10W

FD413-EA-000 EtherCAT Servo Drive



INTERFACE DESCRIPTION

Multi-Function Connector (X4)

PIN Number	Signal Marks	Function
1	OUT1+	Digital Signal Output Maximum Output Current: 100mA
3	OUT1-	
5	OUT2+	
7	OUT2-	
9	OUT3	Digital Signal Output Maximum Output Current: 20mA
11	OUT4	
20	OUT5	
13	COMO	Common Pin of Digital Output OUT3, 4, 5
15	VDD	24VDC Power Supply Output Voltage Range: 24VDC ± 20%, Maximum Current: 300 mA
17	VEE	
2	COMI	DINx Com Port, Common Pin of Digital Input
4	DIN1	Digital Signal Input VinH (active): 12.5VDC-30VDC, VinL (inactive): 0VDC-5VDC, input freq.: <1KHz
6	DIN2	
8	DIN3	
10	DIN4	
12	DIN5	
14	DIN6	
16	DIN7	
19	AIN1 +(MA/)	Analog Input Resolution: 12 Bit, Input Resistance: 350 KΩ Analog Bandwidth: 1KHz, Input Voltage Range: -10V +10V
21	AIN1- (MB/)	
23	AIN2+ (MZ/)	Analog Input Resolution: 12 Bit, Input Resistance: 350 KΩ Analog Bandwidth: 1KHz, Input Voltage Range: -10V +10V
25	AIN2-	
27	MA+/(MA)	Pulse Input Input Voltage: 3.3V-24V Maximum Frequency: 500KHz
29	MA-	
31	MB+/(MB)	
33	MB-	
35	MZ+/(MZ)	
18	MZ-	
22	+5V	5VDC Power Supply Output Maximum Current: 100mA
24	GND	
26	ENCO_Z	Encoder Output Voltage: Voh=3.4V, Vol=0.2V Maximum Current: ±20mA, Maximum Frequency: 10MHz
28	ENCO_Z	
30	ENCO_B	
32	ENCO_B	
34	ENCO_A	
36	ENCO_A	

X4

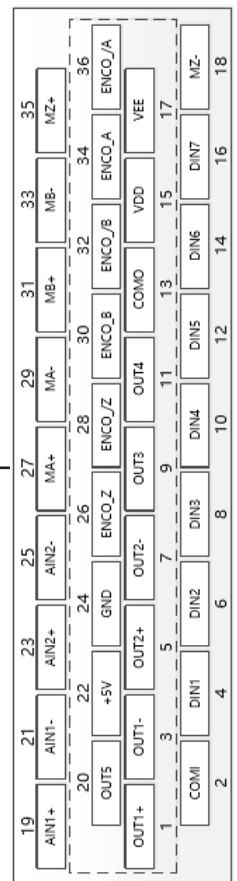

FD413-EA-000 EtherCAT Servo Drive



INTERFACE DESCRIPTION

RS232 Port (X3)

PIN Number	Signal Marks	Function
1	NC	Reserved
2	NC	Reserved
3	TX	Send Controller Data
4	GND	Signal Ground
5	NC	Reserved
6	RX	Receive Controller Data
7	NC	Reserved
8	NC	Reserved

X3

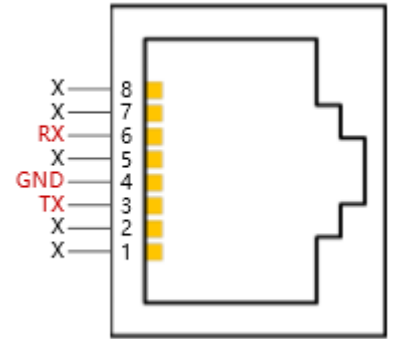

Encoder Input (X5)

PIN Number	Signal Marks	Function
1	+5V	5VDC Positive Terminal of Power Output
2	GND	Negative Terminal of Power Output
3	CLOCK+	Positive Terminal of Clock
4	CLOCK-	Negative Terminal of Clock
5	SD	Data Signal
6	/SD	Data Signal

X5

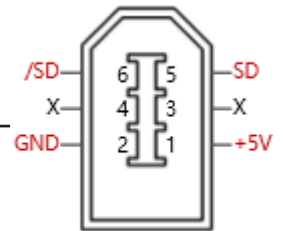

EtherCAT Communication Port Input (X6A)

PIN Number	Signal Marks	Function
1	RD+	Receive Data
2	RD-	Receive Data
3	TD+	Send Data
4	NC	Reserved
5	NC	Reserved
6	TD-	Send Data
7	NC	Reserved
8	NC	Reserved

X6A



EtherCAT Communication Port Output (X6B)

PIN Number	Signal Marks	Function
1	RD+	Receive Data
2	RD-	Receive Data
3	TD+	Send Data
4	NC	Reserved
5	NC	Reserved
6	TD-	Send Data
7	NC	Reserved
8	NC	Reserved

X6B